



The Mercedes-Benz eVito.

Electric Panel Van model.

Prices effective from 5 July 2021.

Mercedes-Benz





Contents

> Model overview	3
> Trims	
eVito PROGRESSIVE	4
> Colours and Upholstery	5
> Equipment	6
> Charging options	12
> Battery and eMotor	13
> Range, Performance and CO₂ emissions	14
> Weights and payloads	14
> Dimensions	15
> eReady finance	
Latest eVito Panel Van offer	17
> List prices	18
> EQ Ready App	19
> After care	20

Please note

This document provides information about the model range line-up and specifications of the Sprinter. It also contains key details about options, economy and performance of all variants. Details are correct at time of publication and are subject to revision. Any images used in this document may not reflect UK specification and are for illustrative purposes only. Images may show optional equipment which does not form part of UK standard specification.

The Mercedes-Benz eVito.

1 van model:	Panel Van – 3 seats
2 lengths:	L2: 5,140mm or L3: 5,370mm
1 trim:	PROGRESSIVE
Charging power:	AC 7.2kW (Standard)
3 speed limiters:	75 mph (120 KM/h) – (Standard) 62 mph (100 KM/h) – (Optional) 50 mph (80 KM/h) – (Optional)

Combined WLTP ranges:
91 miles – 92 miles (120 km/h)*

Charging times:**

- AC 7.2kWh **0-100% in 6 hours**



Discover more about the other Mercedes-Benz Vito diesel models in our range:

➤ [The Vito diesel range](#)

Discover more about the other Mercedes-Benz electric models:

➤ [The electric vehicles range](#)

* Electrical WLTP range for the eVito Panel Van model in miles (Km): 83 (130) – 103 (166). Electrical consumption in kWh/100 km: 24.4 – 30.2; CO₂ emissions in g/km: 0. Figures correct as of November 2020. For real time data visit https://voc.i.daimler.com/voc/gb_en.
 ** Charging times are subject to the power available at the location where the vehicle will be charged as well as factors such as temperature and type of cable used.

The eVito PROGRESSIVE.

Panel Van option available. Features include:

Interior

- 50 mph speed limiter
- Driver and co-driver airbag
- Comfort (eight-way adjustable) driver's seat
- Double co-driver seat
- Locking glovebox
- TEMPATIC air conditioning

Exterior

- Adaptive brake light
- Aerodynamic underbody panelling
- Facelift grille design with chrome fins
- Heat-insulating glass
- Heated, electrically adjustable exterior mirrors
- Rear door without window, double-wing, 180°
- Reverse cam

Safety, security and connectivity

- Audio 30 with DAB radio, colour touchscreen, Apple Car Play and Android Auto
- Charging cable, mode 3 (type 2, 3x32A), 8m
- Double locks
- Hill-Start assist
- Integrated connected Thatcham approved alarm system
- Mercedes PRO connect (via an App).



Upgrade your eVito PROGRESSIVE with our PLUS Pack for £1,260.

- Includes:**
- PARKTRONIC parking sensor displays
 - Electrically folding exterior mirrors
 - Full wheel cover
 - 75mph Speed Limiter

Upgrade

From £40,895[^]

[^] Based on a eVito Van PROGRESSIVE L2.

• 2 lengths available • Charging times

L2: 5,140mm
L3: 5,370mm

6 hours using the Wallbox Type 2: (2 x 16 A | 7.2 kW)[†]
20 hours using a regular power outlet: (1 x 10 A | 2.3 kW)[†].

Government OZEV grant of up to £6,000

The eVito is eligible for a Government OZEV grant that gives businesses 35% off the purchase price, up to a maximum of £6,000*.



▶ Arrange a test drive at your nearest Dealership

* Vehicle purchase price is calculated on base vehicle only (excluding any optional equipment), it excludes delivery charges and first registration fee. The grant will be applied after any vehicle discount has been offered and includes VAT and number plate costs. For more information, visit: <https://www.gov.uk/plug-in-car-van-grants>.

† Charging times are subject to the power available at the location where the vehicle will be charged as well as factors such as temperature and type of cable used.



The Mercedes-Benz eVito

Colours and upholstery.

Solid paints



Arctic white (Standard)



Pebble grey



Jupiter red



Steel blue



Granite green

Metallic paints



Obsidian black



Brilliant silver



Dark graphite grey



Selenite grey



Cavansite blue



Hyacinth red

Interior upholstery

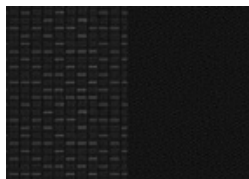

Black Caluma seat upholstery (Standard)

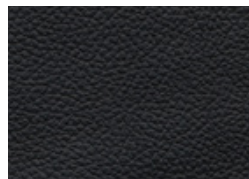

Black leatherette seat upholstery

➤ [For paint pricing, see page 6](#)

➤ [For upholstery pricing, see page 8](#)

Equipment (standard and optional overview).



Every eVito model comes with a host of standard features, plus a range of optional equipment and packages you can add to enhance your van.

Key: ● Standard ○ Optional ◇ Equipment dependant option available — Not available

Equipment	Description	Option code	Progressive Panel Van	Basic Price exc. VAT	Basic Price inc. VAT
Upgrade packages					
Exterior, Interior and parking	PLUS package The PLUS package is the perfect upgrade to the eVito PROGRESSIVE and includes: Electrically foldable mirrors (F64) Full wheel covers (RD8) 75mph speed limiter (MD3) PARKTRONIC parking sensors (EZ8)	N1RZ	○	£1,260.00	£1,344.00
Mirrors	Mirror package The Vito Mirror package uses automatically dimming mirrors and electrically folding outside mirrors to increase the driving comfort and driving safety.	FP2	○	£340.00	£408.00

Exterior Features					
Bodywork	Carrier bars	D15	○	£150.00	£180.00
	Chrome radiator grille Only available in conjunction with painted bumpers (CM2).	FK2	●	£110.00	£132.00
	Roof rails Maximum load of 150 kg, when supported by three carrier bars.	D12	○	£380.00	£456.00
Paint	Bumpers can be painted The surfaces have been pre-treated so the bumpers can be painted in the desired colour at a later date.	CM3	○	£115.00	£138.00
	Colour-coded front & rear bumpers	CM2	○	£315.00	£378.00
	Metallic paint	/	○	£565.00	£678.00
Tyres	Mud and slush tyres The M+S tyres can improve traction and lateral support in wintry road conditions, improving driving safety on snow, ice and mud.	RM1	○	£145.00	£174.00
	Summer Tyres		●	£0.00	£0.00
Wheels	17" Steel wheels Wheel: 6.5 J x 17 ET 51 Tyres: 225/55 R17.	RS7	●	£0.00	£0.00

Changes to individual option availability and combinations may occur depending on vehicle specification choices and the continuing evolution and adaptation of our product range. These changes may not be immediately reflected in this document as they occur, but will be introduced at the next revision opportunity.

Equipment (standard and optional overview).

Equipment	Description	Option code	Progressive Panel Van	Basic Price exc. VAT	Basic Price inc. VAT
Exterior Features (cont.)					
Wheels (cont.)	17" Full wheel cover	RD8	○	£80.00	£96.00
	17" Alloy wheels (20 spoke design) Painted in vanadium silver Wheel: 7 J x 17 ET 51 Tyres: 225/55 R 17.	RK8	○	£950.00	£1,140.00
Interior Features					
Flooring	Velour floor mats The black velour floor mats visually enhance the cockpit and underscore the elegant, sporty wellness ambience in the vehicle.	VL2	○	£45.00	£54.00
Grab Handles	Grab handles for driver's and co-driver's doors	T75	○	£45.00	£54.00
Heating and Ventilation	Heated driver's seat	H16	●	£0.00	£0.00
	Heated co-driver's seat	H15	○	£140.00	£168.00
	Pollen filter The pollen filter keeps even the smallest of particles out of the interior and can therefore protect against allergic reactions.	HF2	○	£40.00	£48.00
	TEMPMATIC air conditioning Cools and dehumidifies the air. Features a particulate filter to remove particles of dust and pollen from the outside air.	HH9	●	£0.00	£0.00
Seating	Comfort driver's seat Single armrest on the side facing the front passenger; fore/aft adjustment (225mm in total, with 4.5mm intervals); stepless adjustment of the seat backrest angle; stepless seat height adjustment; comfort head restraint adjustable for angle and height.	SB1	●	£0.00	£0.00
Seating	Comfort co-driver's seat Comfort driver and co-driver seat with inboard armrests and 4-way adjustable headrests. This deletes the double co-driver seat and therefore limits the cab area to two occupants.	SB2	○	£85.00	£102.00
	Double co-driver seat Bench seat with 2x three-point seat belts, height-adjustable head restraints, and a fixed 17° backrest.	S23	●	£0.00	£0.00
	Driver's seat plus with level sitting surface	SF3	○	£140.00	£168.00
	Co-driver seat plus with level sitting surface	SF4	○	£140.00	£168.00
	Lumbar support for driver's seat Electropneumatically operated dual-cushion 4-way lumbar support, adjusted using a switch on the outer side of the seat cushion. The position of the air cushions can also be adjusted for height.	SE5	○	£105.00	£126.00
	Lumbar support for co-driver's seat Not compatible with Double co-driver seat (S23).	SE4	○	£105.00	£126.00

● Standard ○ Optional ◇ Equipment dependant option available — Not available

Equipment (standard and optional overview).

Equipment	Description	Option code	Progressive Panel Van	Basic Price exc. VAT	Basic Price inc. VAT
Interior Features (cont.)					
Steering Wheel	Height and rake adjustable steering wheel Manually adjustable by 4.8° in tilt and 60mm in/out.	CL1	●	£0.00	£0.00
Storage	Centre console with stowage compartment	FF1	○	£65.00	£78.00
	Locking glove compartment Lock operated using the manual emergency key which is integrated within the electronic ignition key.	F66	●	£0.00	£0.00
Trim and Upholstery	Black Tunja seat upholstery	VY2	●	£0.00	£0.00
	Black leatherette seat upholstery The black man-made leather lends the interior a comfortable aspect and impresses with its low-maintenance surface.	VU9	○	£90.00	£108.00
Technology, Software & Electrics					
Audio Entertainment	Audio 30 7.8 cm (7 inch) touchscreen DAB+ radio includes Smartphone Integration via Apple® CarPlay and Android Auto and also the Bluetooth® interface with audio streaming and hands-free function for making phone calls while driving with minimal distraction. Includes USB ports.	E3C	●	£0.00	£0.00
Audio Entertainment	Audio 40 The 7.8cm (7 inch) touchscreen and integral navigation offers versatile and intuitive communications and infotainment options. The indications and displays of the navigation with 3D city views and landmarks are attractive and easy to understand. Further highlights include the digital radio DAB+, Smartphone Integration via Apple® CarPlay and Android Auto and also the Bluetooth® interface with audio streaming and hands-free function for making phone calls while driving with minimal distraction. Two USB interfaces allow the charging of mobile end devices in the vehicle, amongst other things.	EA4	○	£660.00	£792.00
Keys	Two additional master keys	FZ9	○	£105.00	£126.00
Driver's Assistance & Safety					
Airbags	Driver's airbag	/	●	£0.00	£0.00
	Co-driver airbag	SA6	●	£0.00	£0.00
	Driver thorax-pelvis sidebag	SH1	○	£195.00	£234.00
	Co-driver thorax-pelvis sidebag	SH2	○	£195.00	£234.00
Driver's Assistance	Active ESP The adaptive Electronic Stability Program can support the driver in critical driving dynamics situations by generating direction-stabilising brake forces.	BB9	●	£0.00	£0.00

● Standard ○ Optional ◇ Equipment dependant option available — Not available

Equipment (standard and optional overview).

Equipment	Description	Option code	Progressive Panel Van	Basic Price exc. VAT	Basic Price inc. VAT
Driver's Assistance & Safety (cont.)					
Driver's Assistance (cont.)	Anti-theft protection package Thatcham category 1 approved. Cab interior and load-space monitoring with battery back-up siren and tow-away protection.	FY1	●	£0.00	£0.00
	Comfort overhead control panel LED interior lighting including cab downlighting and co-/driver reading lamps; also includes a convenient spectacles compartment.	LC4	○	£150.00	£180.00
	Headlight assistant A windscreen sensor continuously monitors light conditions and automatically switches the dipped beams on/off upon reaching pre-defined limits.	LA2	●	£0.00	£0.00
	Jack	Y36	○	£55.00	£66.00
	Rain sensor The rain sensor automatically regulates the wiping frequency of the windscreen wipers with activated intermittent wiping, which makes things easier for the driver.	JF1	○	£110.00	£132.00
Driver's Assistance	Speed Limiter 80km/h	MK5	●	£0.00	£0.00
	Speed limiter 120 km/h	MD3	○	£135.00	£162.00
	Tyre pressure monitoring, wireless Monitors air pressure in all 4 wheels. Slight pressure variances generate a visual warning. Sudden, extreme pressure losses trigger an additional acoustic warning.	RY2	●	£0.00	£0.00
Parking	PARKTRONIC parking sensors	EZ8	○	£720.00	£864.00
	Reversing camera	FR8	●	£0.00	£0.00
	Reversing warning device The reverse warning alarm warns pedestrians and other road users audibly of the reversing vehicle and thereby enhances their safety.	JW0	○	£90.00	£108.00
Safety Equipment	Accident recovery and breakdown management The vehicle will automatically call the Mercedes-Benz Customer Assistance Centre at a press of a button to provide the driver with professional help in the event of an emergency.	EY6	●	£0.00	£0.00
	First aid kit	Y10	○	£45.00	£54.00
	Fire extinguisher 1kg	YF7	○	£120.00	£144.00
	PRE-SAFE The PRE-SAFE* anticipatory occupant protection system can detect critical driving situations at an early stage and initiate preventive protection measures.	JP1	○	£325.00	£390.00
	Warning Triangle	Y44	○	£45.00	£54.00

● Standard ○ Optional ◇ Equipment dependant option available — Not available

Equipment (standard and optional overview).

Equipment	Description	Option code	Progressive Panel Van	Basic Price exc. VAT	Basic Price inc. VAT
Lighting					
Lighting	Blinker lights behind on roof The additional turn signal lamps on rear of roof improve the visibility of the vehicle, thus enhancing perceptual safety.	L84	○	£135.00	£162.00
	Halogen front fog lights Controlled via a push button next to the steering wheel.	L16	○	£195.00	£234.00
	Interior and ambient lighting	LP1	○	£220.00	£264.00
	LED lightstrip in load compartment	LC2	○	£95.00	£114.00
Loading & Towing					
Bulkhead	Full-width partition The full-width bulkhead at B-pillar protects driver and front passenger from the load and shields the driver compartment from the load compartment, keeping dirt, dust and noise away from the driver's compartment.	D50	●	£0.00	£0.00
	Full-width partition with 1 window The full-width partition wall on the B-pillar with window allows a view into the cargo area or the view to the rear and shields the driver's compartment from the load compartment.	D51	○	£65.00	£78.00
Gross Vehicle Weight (GVW)	Gross vehicle weight 3.2T	XA5	●	£805.00	£966.00
Load Area	Interior wood panelling to roof height in load compartment The 5 mm-thick wooden panelling of the vehicle sidewalls extending up to roof height protects the sheet metal in the load compartment from damage caused by the cargo.	VA2	○	£280.00	£336.00
	Wood load flooring Multiple-bonded 10 mm thick weatherproof plywood floor, coated with hard-wearing phenolic resin film, and featuring a non-slip textured grid surface.	V43	●	£0.00	£0.00
Mirrors & Windows					
Mirrors	Electrically folding wing mirrors Fold-in/out function is operated via controls in the driver door.	F64	●	£190.00	£228.00
	Heated, electrically adjustable wing mirrors Mirror heating reduces condensation in cold weather and prevents icing-up of the mirrors. The exterior mirrors are heated automatically upon vehicle start when the outside temperature is low or when the rear defrost function is activated.	F68	●	£0.00	£0.00
Windows	Black-tinted windows in rear 90% window tint offers attractive thermal and privacy protection. Applies to all windows after the B-pillar.	W70	—	£0.00	£0.00
	Heat-insulating glass Windscreen (laminated glass), side windows and rear window (single-pane safety glass) are tinted green, reducing the sunlight's heating effect on the interior.	H20	●	£0.00	£0.00

● Standard ○ Optional ◇ Equipment dependant option available — Not available

Equipment (standard and optional overview).

Equipment	Description	Option code	Progressive Panel Van	Basic Price exc. VAT	Basic Price inc. VAT
Mirrors & Windows (cont.)					
Windows (cont.)	Sliding window in left sliding door	W18	○	£355.00	£426.00
	Sliding window in right sliding door	W19	○	£355.00	£426.00
Charging Accessories					
Cables	8m Charging cable Mode 3 (type 2, 3x32A), 8m	E9L	●	£0.00	£0.00

● Standard ○ Optional ◇ Equipment dependant option available — Not available

Charging options – maximise efficiency and reduce downtime.

› The eVito can be charged via Alternating Current (AC) only.

AC is more cost effective for overnight charging and requires longer intervals to fully charge but uses less energy:

- AC 7.2kW: 0-100% in 6 hours†
- AC 2.3 kWh: 0-100% in 20 hours†.

› Managing range and battery performance.

The eVito uses a process called recuperation that recovers energy when the vehicle is decelerating to help you efficiently manage your vehicle's range. There are 4 recuperation modes available, which can be adjusted via the gearshift paddles. The greater the recuperation, the faster you decelerate and therefore, the more energy your vehicle will regenerate:

- D-** This mode will enable you to get maximum range from your eVito. It has maximum recuperation and fastest deceleration. Due to the deceleration being so strong, your vehicle will automatically activate your brake lights.
-
- D** This mode has less recuperation than D- and has similar deceleration levels to a diesel Vito.
-
- D+** This mode has significantly lower recuperation levels and therefore will decelerate at a slower rate than a diesel Vito.
-
- D++** This is a coasting mode, meaning your vehicle will have no deceleration and will significantly reduce your vehicle's range.
-

Free Smart Charge Point available*

We'll install a NewMotion Home Fast Smart charge point at your home for smart, safe and convenient charging.



† Charging times are subject to the power available at the location where the vehicle will be charged as well as factors such as temperature and type of cable used.

* Subject to eligibility. Terms and conditions apply. Please speak to your preferred eReady Dealer for more information.

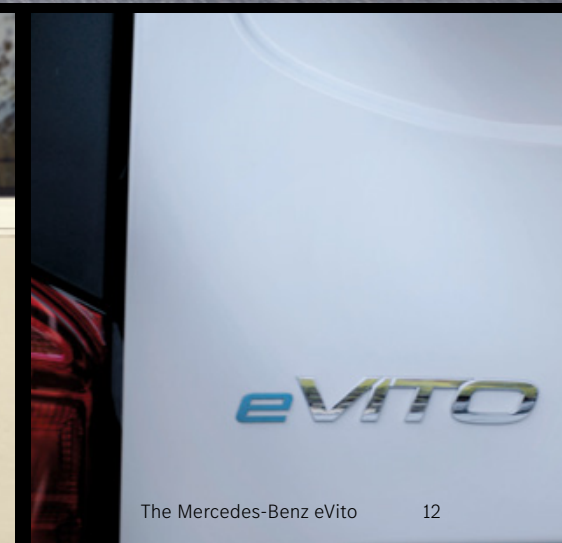

Battery and eMotor.

	PROGRESSIVE
Engine specifications	eVito
Fuel	Electricity
Output, max.	85kW
	114hp
Range	92miles*
Torque, max.	295Nm
Driven Axle	Front
Battery Composition	Lithium Ion
Battery Capacity	41kWh (35kWh useable)
Battery Voltage	365
Battery Charging Power	7.4kW
Battery Charging Time	AC 0-100% - 6 hours**
Charging cable	8m long - Type 2, 3x32A

* Electrical WLTP range for the eVito Panel Van model in miles (Km): 83 (130) - 103 (166). Electrical consumption in kWh/100 km: 24.4 - 30.2; CO₂ emissions in g/km: 0. Figures correct as of November 2020. For real time data visit https://voc.i.daimler.com/voc/gb_en. **Charging times are subject to the power available at the location where the vehicle will be charged as well as factors such as temperature and type of cable used.

Did you know the average commercial vehicle in Europe does less than 62 miles[^] a day?

[^] Mercedes-Benz research analysed 1.6 million journeys anonymously on the EQ Ready app and 96% of all journeys recorded were shorter than 100km (62 miles).

Range, performance and CO₂ emissions.

Model	CO ₂ emissions (g/km)	WLTP Range (Miles)					WLTP Range (Km)				
		Combined	Low (Extra Urban)	Medium (Urban)	High (Rural)	Extra High (Motorway)	Combined	Low (Extra Urban)	Medium (Urban)	High (Rural)	Extra High (Motorway)
PROGRESSIVE – Panel Van											
eVito Van L2	0	92.0	103.0	103.0	95.0	81.0	148.0	166.0	166.0	153.0	130.0
eVito Van L3	0	91.0	102.0	102.0	94.0	81.0	147.0	164.0	164.0	152.0	130.0
Model	CO ₂ emissions (g/km)	Energy Consumption (WLTP) kWh/100km									
		Combined	Low (Extra Urban)	Low-Medium	Medium (Urban)	High (Rural)	Extra High (Motorway)				
Panel Van – PROGRESSIVE											
eVito Van L2	0	27.2	24.4	24.6	24.6	26.6	30.2				
eVito Van L3	0	27.3	24.6	24.7	24.7	26.7	30.2				

All figures are based on a standard specification.

The choice of wheels and transmission may affect CO₂ emissions.

The indicated values were determined according to the prescribed measurement method – Worldwide Harmonised Light Vehicle Test Procedure (WLTP). Figures shown may include options which are not available in the UK. For Battery Electric Vehicles (BEV) figures determined with battery fully charged. These models require mains electricity for charging. Figures shown are for comparability purposes; only compare with other vans tested to the same technical procedures. Figures may not reflect real life driving results, which will depend upon a number of factors including the starting charge of the battery, factory-fitted options, accessories fitted (post registration), variations in weather, driving styles and vehicle load. Further information about the test used to establish fuel consumption and CO₂ figures can be found at <http://www.mercedes-benz.co.uk/WLTP>

Weights and payloads.

Model	Gross Vehicle Weight (Kg)	Unladen Weight (Kg)	Payload (Kg)	Gross Train Weight (Kg)
PROGRESSIVE – Panel Van				
eVito Van L2	3,200	2,295	905	3,200
eVito Van L3	3,200	3,200	890	3,200

Please note: The stated payload weights are correct according to type approval data. The specific payload values for UK supplied vehicles may differ. The figure quoted only accounts for equipment which is included in the UK product offer as standard. Please speak to a dealer for final vehicle configurations and weights once all options and accessories have been added.

Dimensions.

PANEL VAN L2

Wheelbase	Wheelbase length	3,200mm
	Turning circle	11.8m
	Track circle	11m
	Front track width	1,666mm
	Rear track width	1,646mm
Vehicle	Length	5,140mm
	Height (unladen)	1,910mm
	Width (inc. wing mirrors)	2,249mm
	Ground clearance	116mm
Load compartment	Length	2,831mm*
	Load volume	6.0m ³
	Max. width	1,685mm
	Width between wheel arches	1,270mm
	Height	1,391mm
	Rear loading height (step height from ground to load floor)	558mm

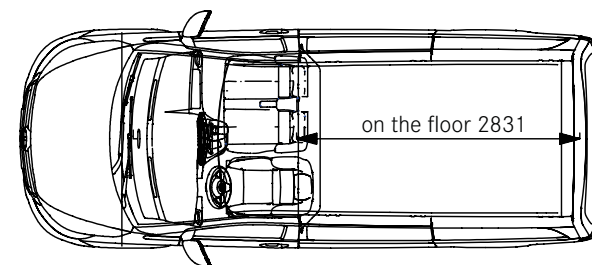
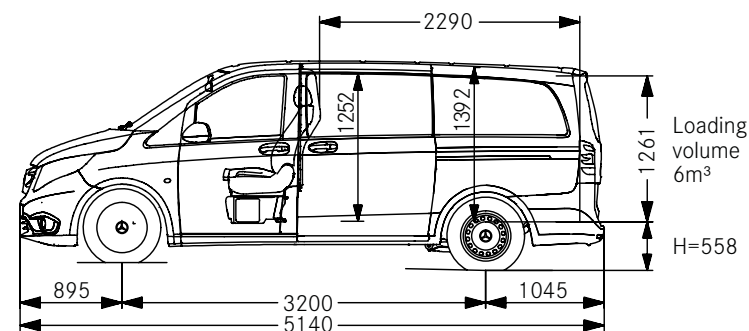
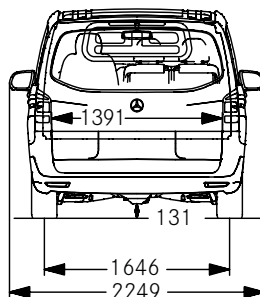
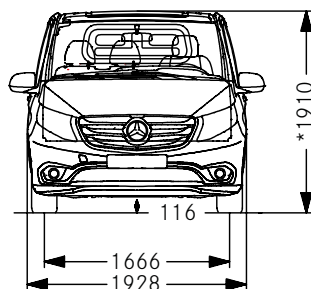

H ca. / *558 *unloaded
Turning circle Ø ca. 11.8m
Track circle Ø ca. 11m

*Measured on vehicle floor and includes 370mm for the space beneath the front seats.

Dimensions.

PANEL VAN L3

Wheelbase	Wheelbase length	3,430mm
	Turning circle	12.5m
	Track circle	12m
	Front track width	1,666mm
	Rear track width	1,646mm
Vehicle	Length	5,370mm
	Height (unladen)	1,910mm
	Width (inc. wing mirrors)	2,249mm
	Ground clearance	116mm
Load compartment	Length	3,061mm*
	Load volume	6.6m ³
	Max. width	1,685mm
	Width between wheel arches	1,270mm
	Height	1,391mm
	Rear loading height (step height from ground to load floor)	558mm

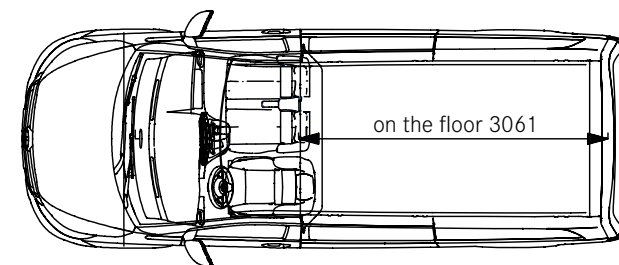
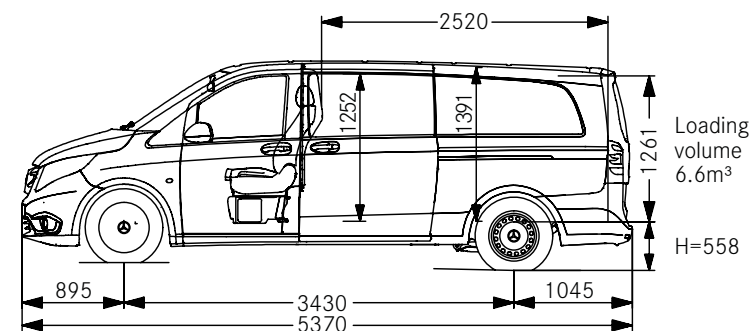
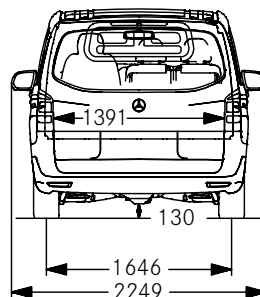
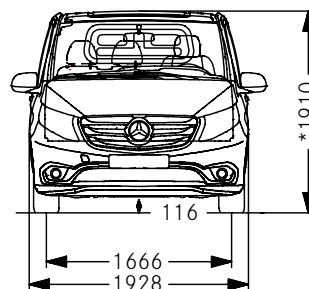

H ca. / *558 *unloaded
 Turing circle Ø ca. 12.5m
 Track circlce Ø ca. 12m

*Measured on vehicle floor and includes 370mm for the space beneath the front seats.

eReady finance – the flexible way to purchase your electric van.

If you're interested in an electric van but the idea of a lengthy finance agreement puts you off, our flexible eReady finance terms start from as little as 12 months. This allows you to make the switch with a level of commitment you feel comfortable with, and with a wide range of options at the end.

- Contract Hire deals available from 12 months
- Love your electric van? You can purchase it at the end of the agreement
- Want to explore your options? Regularly review your finance and vehicle options, then return or part-exchange the van at the end of your contract
- Switch to another electric van in the Mercedes-Benz range when new models become available.

➤ [Learn more about our finance options](#)

or if you'd preferred to talk to a Dealer, find the nearest one to you:

➤ [Find your preferred Dealer](#)

Latest eVito Panel Van offer

Based on an eVito Van L2 PROGRESSIVE*



Finance Monthly Rental	£342.50
Optional Service Care Payment	£12.50
Total Monthly Rental	£355.00
Advance Rental	£2,055.00
Excess Mileage Charge ex. VAT	20 pence per mile

* BUSINESS USERS ONLY.

- 36 month (6+35) Contract Hire agreement.
- 10,000 miles per annum.
- Monthly payment includes the cost of a 36 month Optional Service Care agreement at £12.50 a month, but excludes the cost of other repairs and maintenance.
- Mileage and damage charges apply.
- All prices exclude VAT at 20%.
- Orders/credit approvals on selected eVito Van L2 PROGRESSIVE models only between 01 July 2021 and 30 September 2021, registered by 31 December 2021.
- Mercedes-Benz Finance MK15 8BA.

Prices are correct at time of going to press 07/2021. All prices are subject to any fiscal or legislative changes.

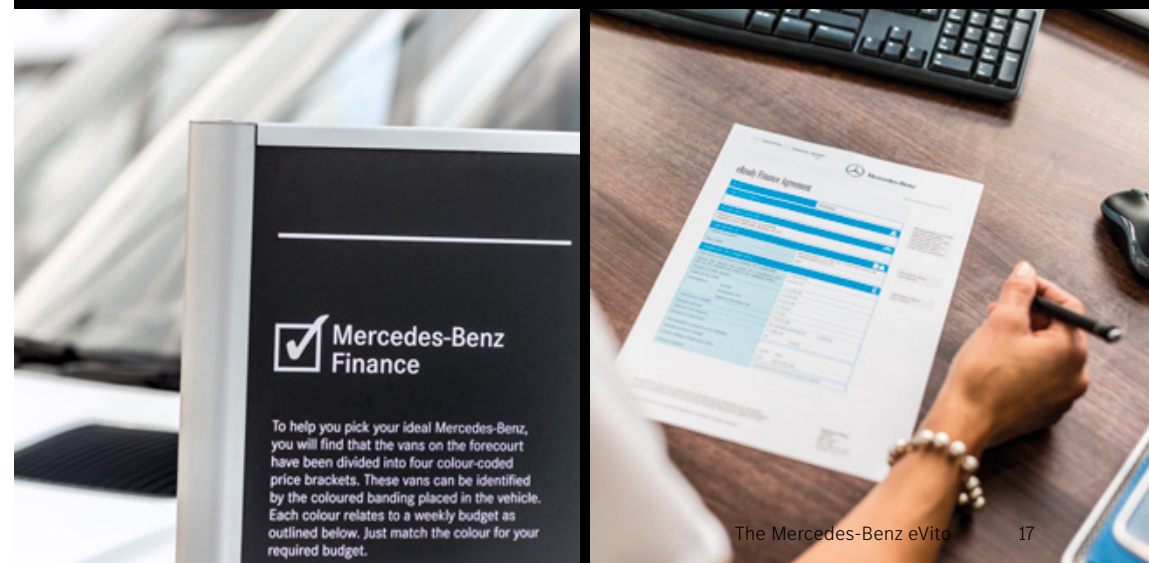

List prices.

Model	Drive	Basic Recommended Retail Price (Ex. VAT)	Basic Recommended Retail Price (Inc. VAT)
PROGRESSIVE – Panel Van			
eVito Van L2	FWD	£40,895	£49,074
eVito Van L3	FWD	£41,425	£49,710

The eVito offers additional saving options including:

Government OZEV grant of up to £6,000

The eVito is eligible for a Government OZEV grant that gives businesses 35% off the purchase price, up to a maximum of £6,000*.



Free Smart Charge Point available**

We'll install a NewMotion Home Fast Smart charge point at your home for smart, safe and convenient charging.

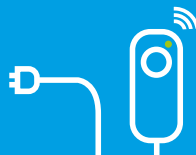

* Vehicle purchase price is calculated on base vehicle only (excluding any optional equipment), it excludes delivery charges and first registration fee. The grant will be applied after any vehicle discount has been offered and includes VAT and number plate costs. For more information, visit: <https://www.gov.uk/plug-in-car-van-grants>

** Subject to eligibility. Terms and conditions apply. Please speak to your preferred eReady Dealer for more information.

This document is for guidance only and must be used in conjunction with a configuration tool prior to final specification decisions and vehicle quotations being prepared and accepted. List prices are quoted ex-factory unless otherwise stated. Delivery charges excluding VAT will be added to model prices quoted in this document. Prices based on standard finish paint choice. Mercedes-Benz Vans UK and authorised Dealers reserve the right to alter specification and vary prices without notice. The availability of options may depend on the chosen base vehicle and other optional equipment specified, and should be confirmed with your Mercedes-Benz Vans Dealer prior to order placement. VAT is calculated at the standard rate of 20%. Mercedes-Benz Vans UK Ltd, Tongwell, Milton Keynes MK15 8BA.

The EQ Ready App.

Are you #eReady?

We know that not every business is ready to go electric – but if you want to find out whether it's right for you, the EQ Ready app is here to help. Take a free virtual test drive and analyse your electric driving potential using your current van, with no obligation and no pressure to make the switch.

- Easily simulate electric driving in your current van.
- Analyse your driving distances and behaviours to get a clear picture of your virtual range and the battery capacity you'd need.
- See public charging stations in your area and add private charging points (such as those owned by your employer or family/friends).
- Test your hypothetical battery's consumption at different temperature scenarios, and experiment with load weights for a realistic and detailed assessment.
- Get set up in seconds by downloading the app on Apple or Android now.



Need further help?

When switching to a brand-new way of keeping your business moving, it's only natural you'll have questions. So, if there's anything you'd like to find out that's not covered in this brochure, then feel free to take a look at:

▶ [The Mercedes-Benz electric van guide](#)

or if you'd preferred to talk to a Dealer, find the nearest one to you:

▶ [Find your preferred Dealer](#)

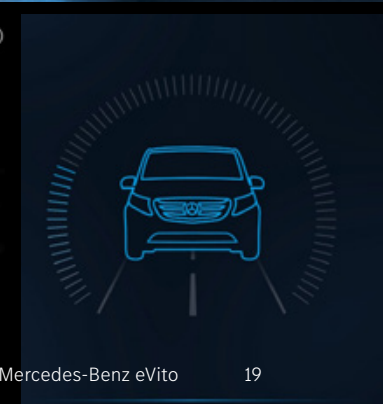
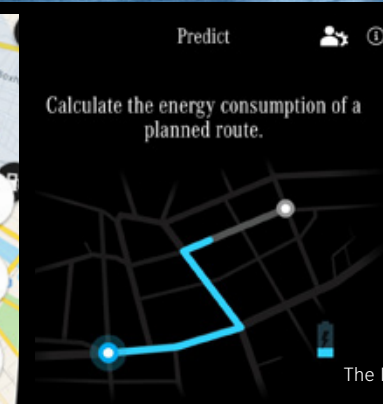
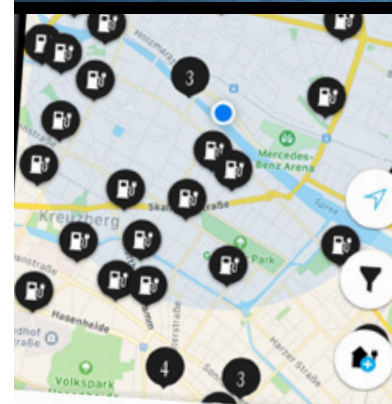

The Mercedes-Benz eVito 19

After care.

Keeping Businesses Moving.

The support we provide doesn't end once you've driven away. We offer a number of ways to keep your business moving long into the future.

› Free roadside assistance

The Mercedes-Benz eVito comes with MobiloVan, our comprehensive roadside assistance cover, available for 24/7 for up to 30 years*. If you misfuel, lose your keys, are involved in a road traffic accident, or if your van is vandalised or won't start, we'll send out a trained technician. With an average roadside repair rate of 80%, you'll be moving again in no time.

[Find out more about MobiloVan](#)

› 3 year warranty

Because we want to help keep businesses moving today and in the future, all our new vans come with a free 3 year unlimited mileage warranty.

› 8-year/100,000km battery guarantee

For peace of mind and reliable performance, the eVito's battery comes with an impressive 8-year/100,000km battery guarantee.

› 24/7 Dealer network

Our nationwide network of approved Dealers is here to help your business maintain momentum. Most Dealers work until midnight and over a third are open 24/7.

[Find out more about our Dealer network](#)

* For a full list of exclusions and all product terms please visit mbvans.co.uk/mobilovan.

